

SKYWING I

Sports & High Mast Light

Key Features

Integrated Breather Valve and Cold Forging Aluminum Heat Sink result in excellent thermal management

Blue Aluminum Corner increase the industrial look and customized color available

Black Frame with extrusion aluminum provide high mechanical strength, best heat dissipation

180°Adjustable Bracket, allows for precise installation

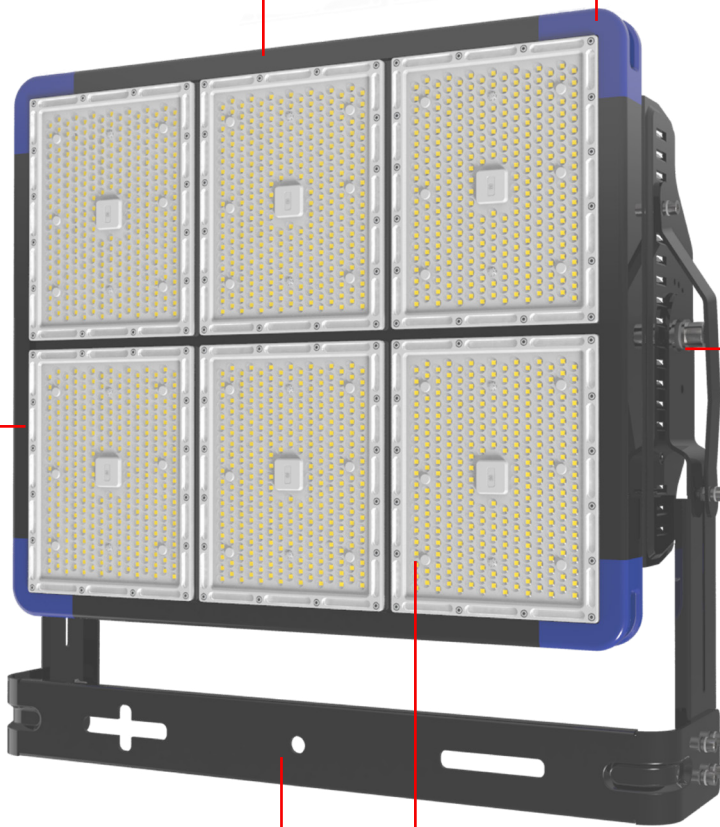

"L" Type extended bracket and arms with 4mm thickness, anti-typhoon rating 17

Optical Polycarbonate Lenses provide high impact resistance IK08 and multiple lighting distributions, 10°/25°/45°/60°/90°



SKYWING I Sports & High Mast Light

ISL-XQCD-200W

Specifications

Optical Data

Power	180W
LED Chips	Lumileds/CREE
Luminous Efficacy	Up to 150 lm/w
Luminous Flux	28118 LM(90°)
CCT	3000K-6500K
Beam Angle	10°/25°/45°/60°/90°
CRI (Ra)	70+/80+

Electrical Data

Driver	Meanwell/Sosen
Input Voltage	AC85-277V
Power Factor	>0.95
Output Voltage	DC42V
Total Harmonic Distortion	< 15%
Driver Efficiency	92%

Others

IP Rating	IP66
Lifespan	60,000Hrs
Housing	Cold Forging Aluminum
Lens Material	Polycarbonate
Fixture Size	300*250*120 mm
Carton Size	405*315*215mm
Net Weight	6.5KG
Gross Weight	7KG

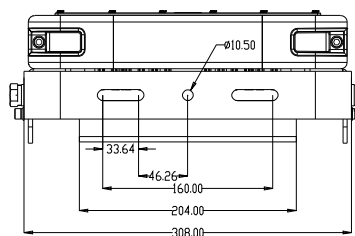
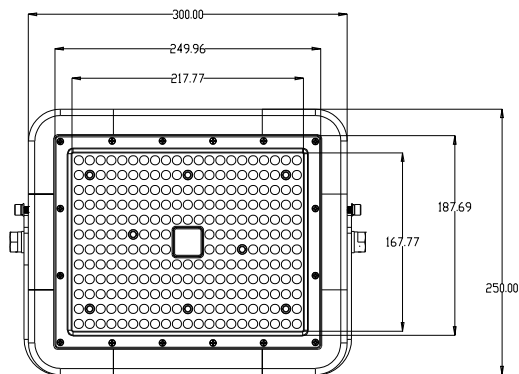

SKYWING I Sports & High Mast Light

ISL-XQCD-360W

Specifications

Optical Data

Power	360W
LED Chips	Lumileds/CREE
Luminous Efficacy	Up to 150 lm/w
Luminous Flux	51585 LM(90°)
CCT	3000K-6500K
Beam Angle	10°/25°/45°/60°/90°
CRI (Ra)	70+/80+

Electrical Data

Driver	Meanwell/Sosen
Input Voltage	AC85-277V
Power Factor	>0.95
Output Voltage	DC42V
Total Harmonic Distortion	< 15%
Driver Efficiency	92%

Others

IP Rating	IP66
Lifespan	60,000Hrs
Housing	Cold Forging Aluminum
Lens Material	Polycarbonate
Fixture Size	460*300*150mm
Carton Size	575*395*245mm
Net Weight	13KG
Gross Weight	13.7KG

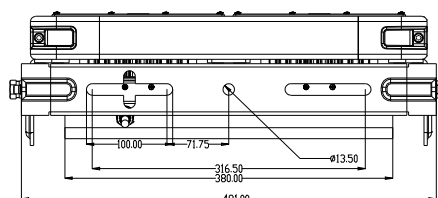
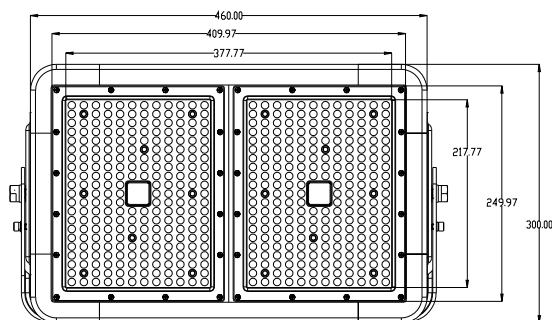

SKYWING I Sports & High Mast Light

ISL-XQCD-540W

Specifications

Optical Data

Power	540W
LED Chips	Lumileds/CREE
Luminous Efficacy	Up to 150 lm/w
Luminous Flux	73756 LM (90°)
CCT	3000K-6500K
Beam Angle	10°/25°/45°/60°/90°
CRI (Ra)	70+/80+

Electrical Data

Driver	Meanwell/Sosen
Input Voltage	AC85-277V
Power Factor	>0.95
Output Voltage	DC42V
Total Harmonic Distortion	< 15%
Driver Efficiency	92%

Others

IP Rating	IP66
Lifespan	60,000Hrs
Housing	Cold Forging Aluminum
Lens Material	Polycarbonate
Fixture Size	670*300*150 mm
Carton Size	785*395*235mm
Net Weight	19KG
Gross Weight	20KG

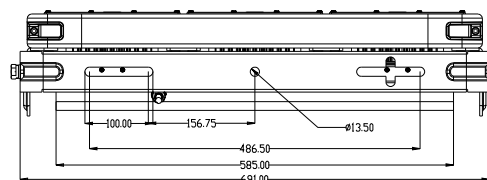
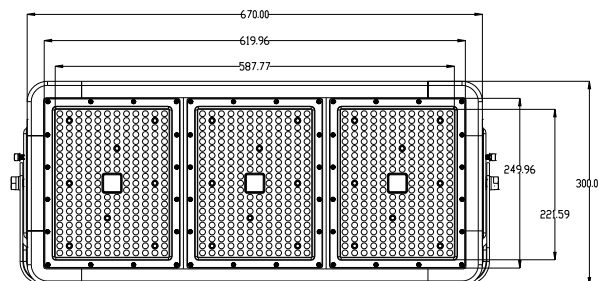
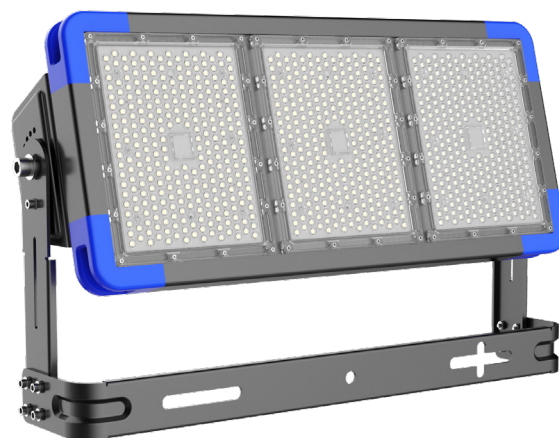

SKYWING I Sports & High Mast Light

ISL-XQCD-720W

Specifications

Optical Data

Power	720W
LED Chips	Lumileds/CREE
Luminous Efficacy	Up to 150 lm/w
Luminous Flux	95365 LM(90°)
CCT	3000K-6500K
Beam Angle	10°/25°/45°/60°/90°
CRI (Ra)	70+/80+

Electrical Data

Driver	Meanwell/Sosen
Input Voltage	AC85-277V
Power Factor	>0.95
Output Voltage	DC42V
Total Harmonic Distortion	< 15%
Driver Efficiency	92%

Others

IP Rating	IP66
Lifespan	60,000Hrs
Housing	Cold Forging Aluminum
Lens Material	Polycarbonate
Fixture Size	560*460*150 mm
Carton Size	670*610*225mm
Net Weight	23KG
Gross Weight	25KG

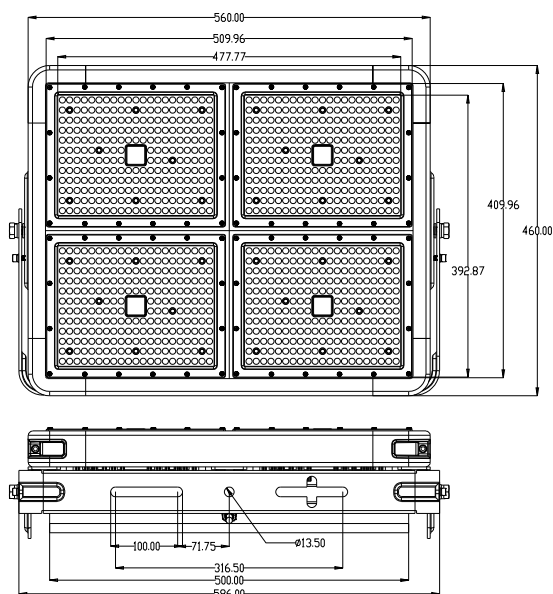
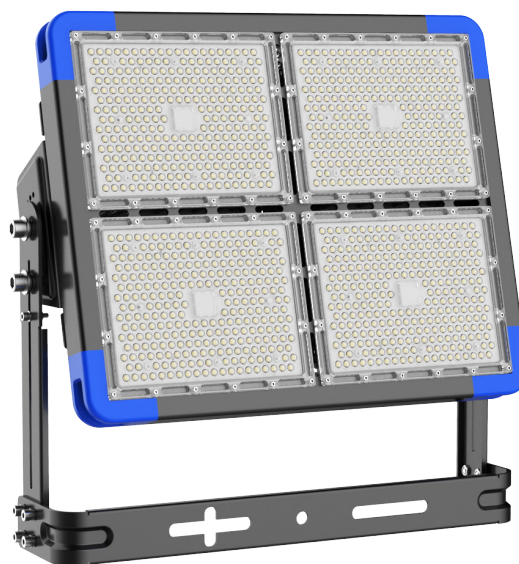

SKYWING I Sports & High Mast Light

ISL-XQCD-1080W

Specifications

Optical Data

Power	1080W
LED Chips	Lumileds/CREE
Luminous Efficacy	Up to 150 lm/w
Luminous Flux	144925 LM(90°)
CCT	3000K-6500K
Beam Angle	10°/25°/45°/60°/90°
CRI (Ra)	70+/80+

Electrical Data

Driver	Meanwell/Sosen
Input Voltage	AC85-277V
Power Factor	>0.95
Output Voltage	DC42V
Total Harmonic Distortion	< 15%
Driver Efficiency	92%

Others

IP Rating	IP66
Lifespan	60,000Hrs
Housing	Cold Forging Aluminum
Lens Material	Polycarbonate
Fixture Size	670*560*200mm
Carton Size	840*655*280mm
Net Weight	37KG
Gross Weight	39KG

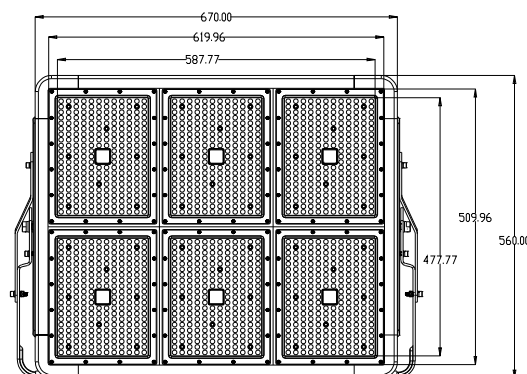
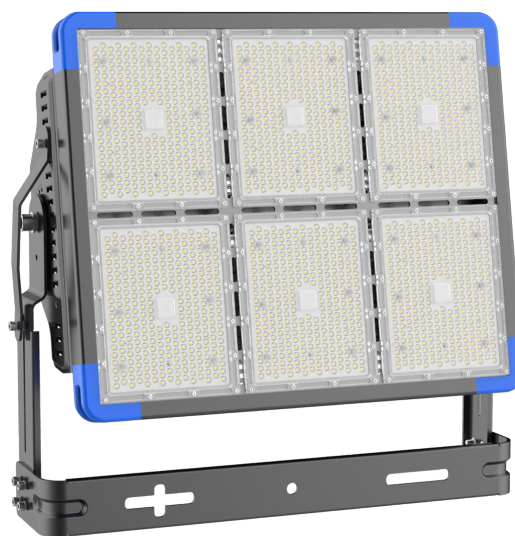

SKYWING I Sports & High Mast Light

ISL-XQCD-1440W

Specifications

Optical Data

Power	1440W
LED Chips	Lumileds/CREE
Luminous Efficacy	Up to 150 lm/w
Luminous Flux	198667 LM(90°)
CCT	3000K-6500K
Beam Angle	10°/25°/45°/60°/90°
CRI (Ra)	70+/80+

Electrical Data

Driver	Meanwell/Sosen
Input Voltage	AC85-277V
Power Factor	>0.95
Output Voltage	DC42V
Total Harmonic Distortion	< 15%
Driver Efficiency	92%

Others

IP Rating	IP66
Lifespan	60,000Hrs
Housing	Cold Forging Aluminum
Lens Material	Polycarbonate
Fixture Size	880*560*200mm
Carton Size	1050*655*300mm
Net Weight	47KG
Gross Weight	50KG

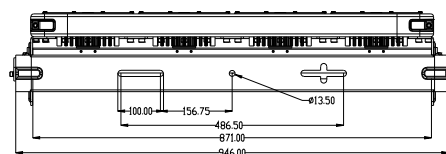
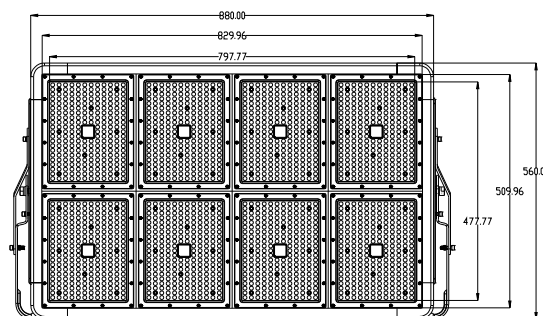
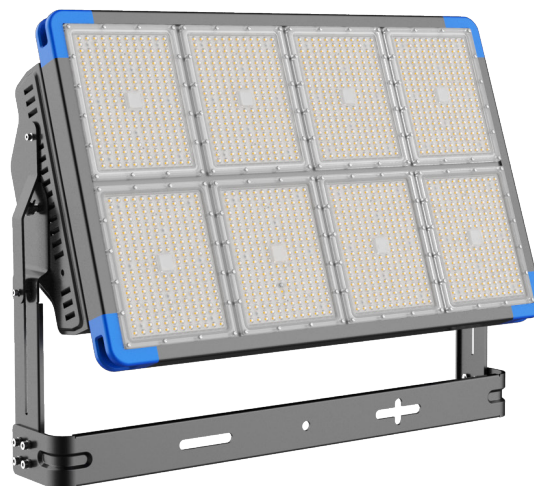

Photometric Diagrams

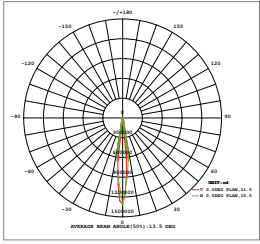

10°

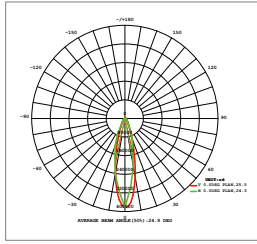

25°

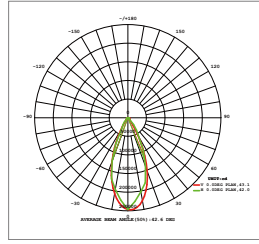

45°

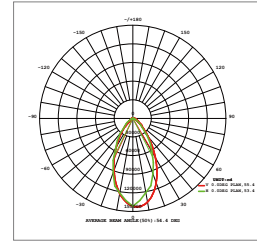

60°

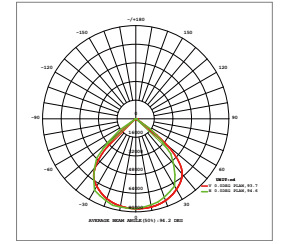

90°

Installations

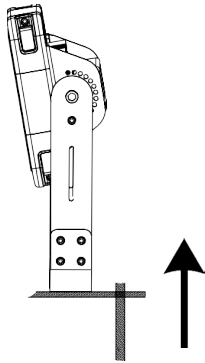

Vertical Mounting

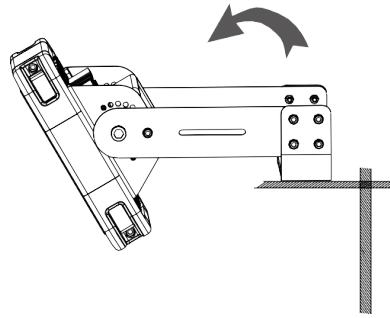

Wall Mounting

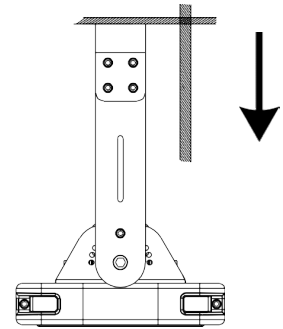

Hanging Mounting

Package

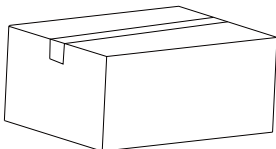
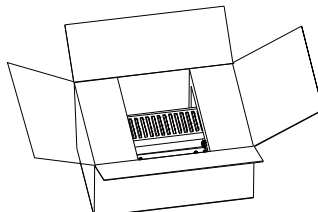
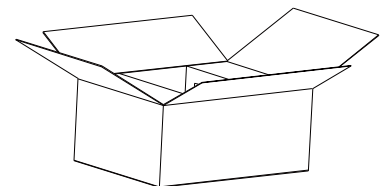
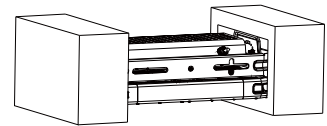
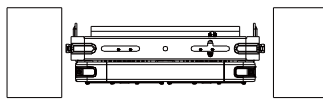
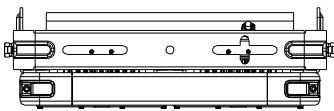

Specifications

Model	ISL-XQCD-200W	ISL-XQCD-360W	ISL-XQCD-540W	ISL-XQCD-720W	ISL-XQCD-1080W	ISL-XQCD-1440W
Power Consumption	200W	360W	540W	720W	1080W	1440W
Input Voltage	AC 85-277V					
LED Chip	Lumileds/CREE					
LED QTY	280 pcs	560 pcs	840 pcs	1120 pcs	1680 pcs	2240 pcs
CRI	Ra>70/Ra>80					
Power Factor	>0.95					
Light efficacy	Up to 150lm/w					
IP Rating	IP66					
Working Temp	- 25°C- +50°C					
Beam Angel	10° /25° / 45° / 60° /90°					
Warranty	5 YEARS/ 7YEARS					
Product Size(MM) Carton Size(MM)	L300xW250xH120MM 405*315*215MM	L460xW300xH150MM 575*395*245MM	L670xW300xH150MM 785*395*235MM	L560xW460xH150 MM 840*655*280MM	L670xW560xH200MM 840*655*280MM	L880xW560xH200MM 1050*655*300MM
N.W/G.W	6.5KG/7KG	13KG/13.7KG	19KG/20KG	23KG/25KG	37KG/39KG	47KG/50KG

Application

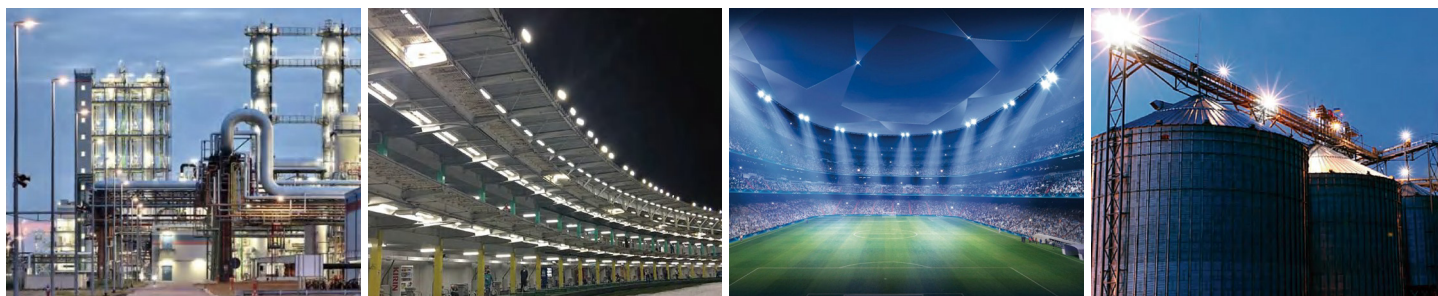

Application: Stadium , Wharf , Airport, Dock, Tower Crane, Large Outdoor Parking Lot, Football Field, Basketball Court, Tennis Court, Golf Course etc.